

Go Green!

Emphasis on Green & Environmental Friendly

Recycling wood





01
HOTEL



Product Applied:
100 / 35 Square Tube, 150 / 50 Square Tube, 204 Triangular,
150 Wall Panel





02 RECREATION



Product Applied:
100 / 25 Square Tube, 50 / 25 Square Tube, 204 Great Wall Plate,
202 High Great Wall Plate, 159 Small Great Wall Plate, 40 / 45 Ceiling

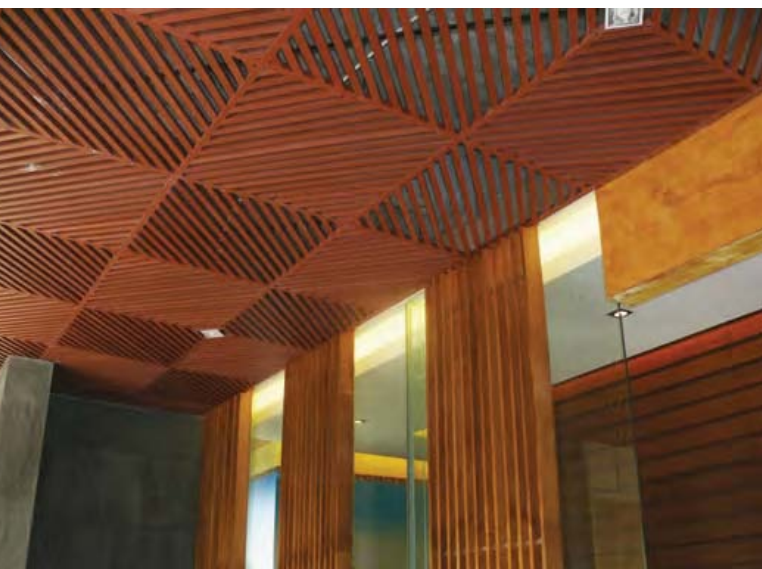

03

OUTDOOR



Product Applied:
100 / 50 Square Tube, 40 / 25 Square Tube, 40 / 45 Ceiling,
140 / 25 Outdoor Floor, 150 Wall Panel



04

BUILDING



Product Applied:
100 / 50 Square Tube, 100 / 25 Square Tube,
51 / 16 Hollow Wood, 204 Great Wall Plate



05

OFFICE



Product Applied:
100 / 50 Square Tube, 40 / 45 Ceiling, 100 Flat Panel,
204 Great Wall Plate, 159 Small Great Wall Plate



Product Applied:
65 / 25 Square Tube, 180 Wall Panel, 202 High Great Wall Plate,
159 Small Great Wall Plate, 51 / 16 Hollow Wood



06

CLADDING







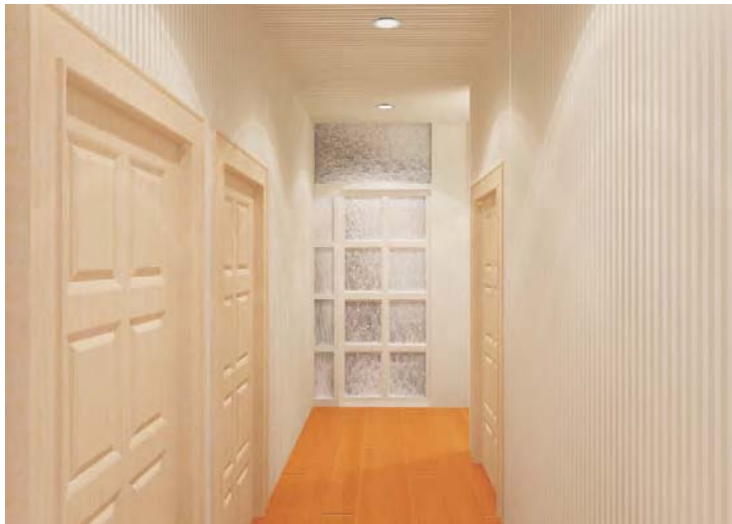





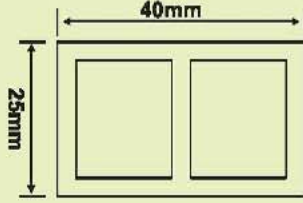

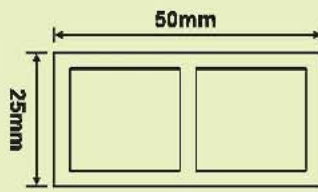

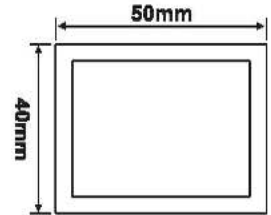

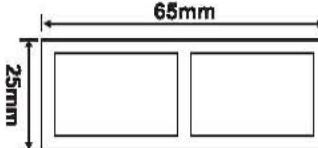

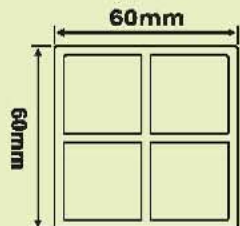
07

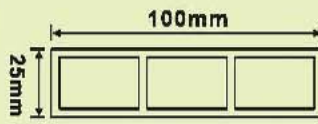
DOMESTIC

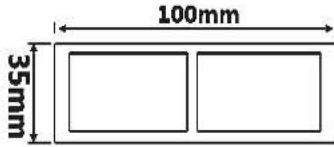

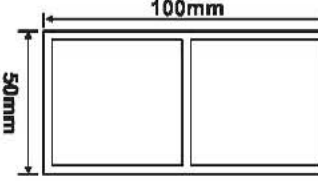
Product Applied:
100 / 35 Square Tube, 40 / 45 Ceiling, 100 Flat Panel,
159 Small Great Wall Plate

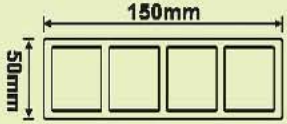

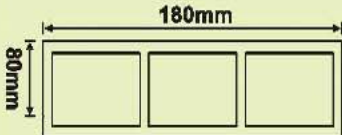







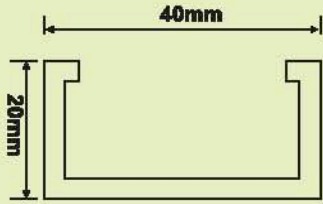

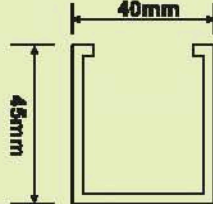

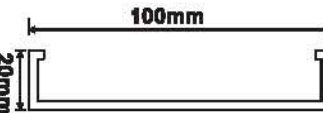

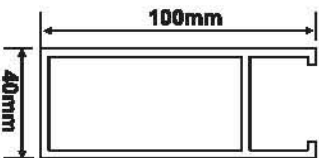

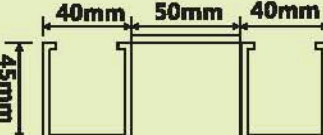

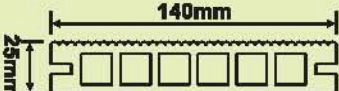
Product	Dimension	Product	Dimension
40 / 25 Square Tube 		50 / 25 Square Tube 	
50 / 40 Square Tube 		65 / 25 Square Tube 	
60 / 60 Square Tube 		100 / 25 Square Tube 	
100 / 35 Square Tube 		100 / 50 Square Tube 	
150 / 50 Square Tube 		180 / 80 Square Tube 	

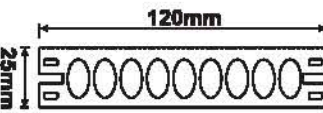

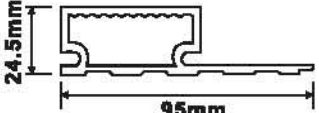



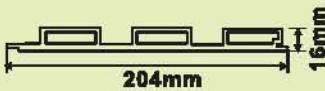



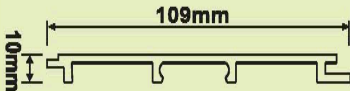

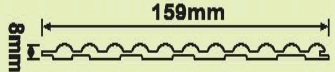

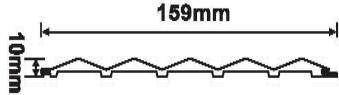

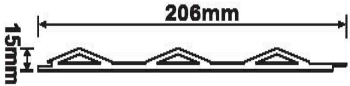

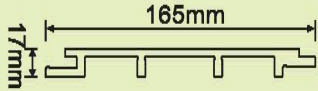
All Items can be custom made. For more Information, please contact us.

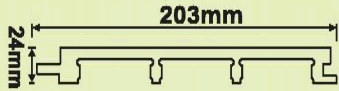

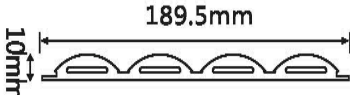

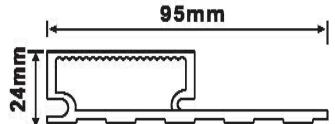

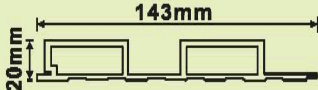
Ceiling, Outdoor Flooring, Acoustic Panel

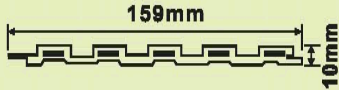
Product	Dimension	Product	Dimension
40 / 20 Ceiling 		40 / 45 Ceiling 	
100 / 20 Ceiling 		100 / 40 Ceiling 	
40 / 45 Ceiling 		140 Outdoor Flooring 	
120 Outdoor Flooring 		90 Acoustic Panel 	
159 / 10 Acoustic Panel 		204 Great Wall Plate 	

All items can be custom made. For more information, please contact us.

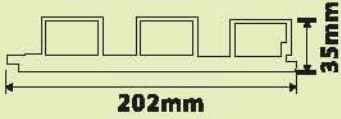
Product	Dimension	Product	Dimension
100 Flat Panel 	 <p>109mm 10mm</p>	159 Small Ripple Panel 	 <p>159mm 8mm</p>
159 Triangular 	 <p>159mm 10mm</p>	204 Triangular 	 <p>206mm 15mm</p>
150 Wall Panel 	 <p>165mm 17mm</p>	180 Wall Panel 	 <p>203mm 24mm</p>
188 Large Ripple Panel 	 <p>189.5mm 10mm</p>	90 Great Wall Panel 	 <p>95mm 24mm</p>
137 Great Wall Plate 	 <p>143mm 20mm</p>	159 Small Great Wall Plate 	 <p>159mm 10mm</p>

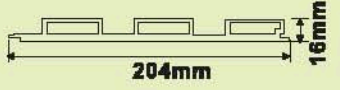
All items can be custom made. For more information, please contact us.

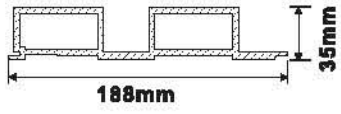
Product	Dimension	Product	Dimension
<p>202 High Great Wall Plate</p> 		<p>204 Great Wall Plate</p> 	
<p>180 Great Wall Plate</p> 			













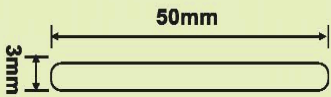

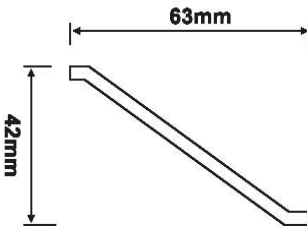

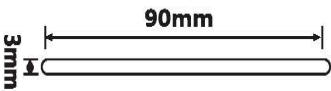

Grid Ceiling

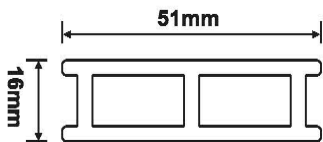

Colour Chart

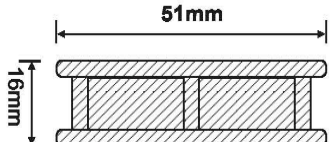

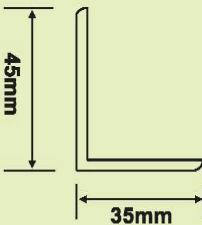
All Items can be custom made. For more Information, please contact us.

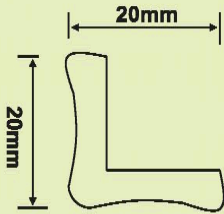
Product	Dimension	Product	Dimension
25 / 3 Shutter 		50 / 3 Shutter 	
63 / 42 Shutter 		90 / 3 Shutter 	
200 / 3 Shutter 		38 / 12 Hollow Wood 	
51 / 16 Hollow Wood 		51 / 16 Wood 	
35 / 45 L-Type Frame 		Decorative Line 	

All Items can be custom made. For more Information, please contact us.

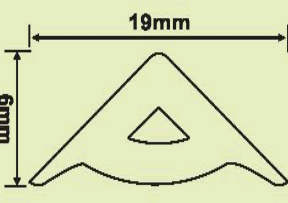
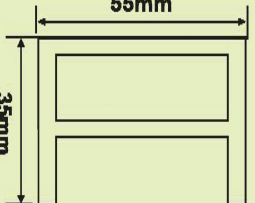
Product	Dimension	Product	Dimension
Decorative Line		Shutter Frame	

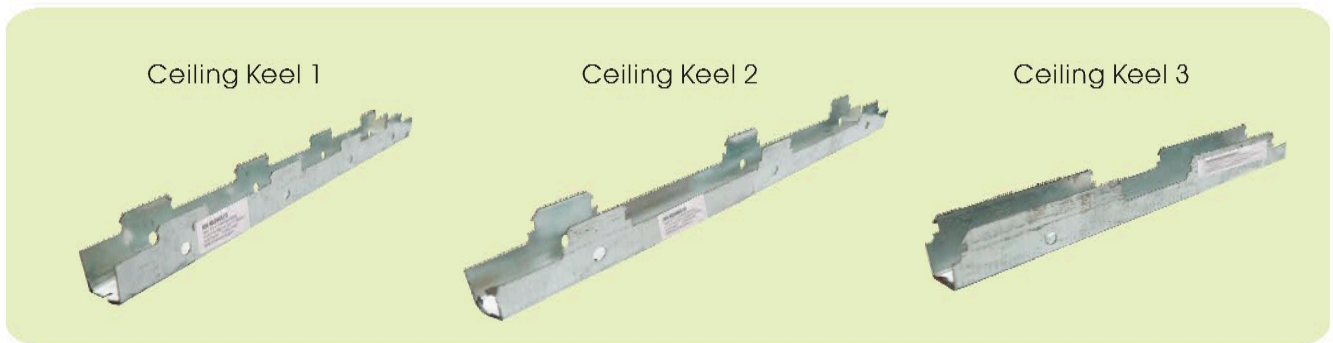

All Items can be custom made. For more Information, please contact us.

Go Green!

Emphasis on Green & Enviromental Friendly

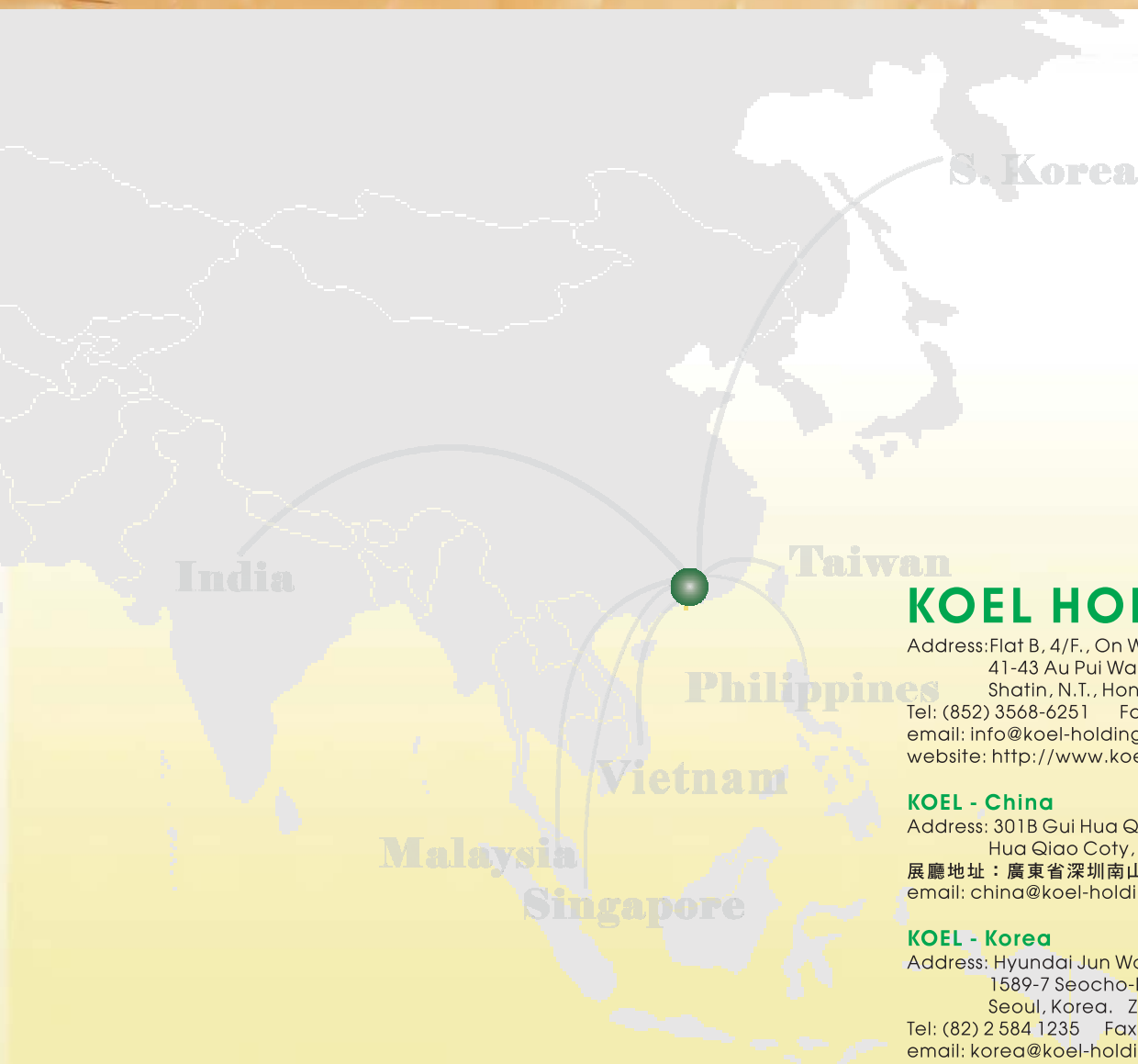

KOEL HOLDINGS LTD

Address: Flat B, 4/F., On Wah Industrial Building,
41-43 Au Pui Wan Street, Fotan,
Shatin, N.T., Hong Kong.
Tel: (852) 3568-6251 Fax: (852) 3568-6252
email: info@koel-holdings.com
website: <http://www.koel-holdings.com>

KOEL - China

Address: 301B Gui Hua Qun Lou, Dong Fang Hua Yuan,
Hua Qiao Coty, Shenzhen, China.

展廳地址：廣東省深圳南山區華僑城東方花園桂花苑裙樓301B
email: china@koel-holdings.com

KOEL - Korea

Address: Hyundai Jun Won Officetel 401,
1589-7 Seocho-Dong, Seocho-Gu
Seoul, Korea. ZIP: 137-073

Tel: (82) 2 584 1235 Fax: (82) 2 584 1245
email: korea@koel-holdings.com

KOEL - Macau

Tel: (853) 6662-9497 Fax: (853) 2821-1527
email: macau@koel-holdings.com

KOEL - Southwest China Branch

email: cd@koel-holdings.com

KOEL - Singapore

email: singa@koel-holdings.com

